

Rechargeable Lithium-ion Battery Cell

EnerCera® Coin ET1210C-H User's Guide

Table of Contents

1.	Introduction	1
2.	Product Description	2
3.	Standards	2
4.	Safety Precautions	3
5.	Instructions for Use	8
6.	Hazardous Materials Used in the Product	10
7.	Storage and Disposal of Used Cells	10
8.	Technical Report	11
	— Nominal Specifications	
	— Exterior Diagram	
	— Structure and Cross-Sectional View	
	— Reference Data	
	— Safety	

1. Introduction

This user's guide (this "Guide") shall apply to rechargeable lithium-ion batteries ("Cell") supplied to customers by NGK Insulators, Ltd. ("NGK").

To ensure the correct use of Cell, please read and understand this Guide thoroughly before using Cell.

Inappropriate use or handling of cell may not provide full performance, and cause unexpected breakdown or shorten the product life.

Make sure that this Guide is always available to persons using Cell.

Unauthorized reproduction of all or part of the contents of this Guide is prohibited. This Guide may be revised without notice, so please check the latest version regularly.

NGK shall design and manufacture Cell in accordance with its own standards for any matter not stipulated in this Guide.

Cell is for industrial use only. Cell is not intended for use by general consumers as a stand-alone product (charge/discharge, integration into equipment, removal from equipment, etc.).

If you intend to use Cell for any of the following purposes, please make sure to contact us beforehand.

- Purposes for which extremely high reliability is required, such as use in systems, machines or equipment that may involve danger to human lives or property, including nuclear control systems, transport equipment (railways, vehicles, aircraft, ships, etc.), medical equipment or safety equipment.
- Other equivalent purposes that require a high level of safety.

2. Product Description

Classification: Rechargeable Lithium-ion Battery Cell

Cell Type: EnerCera® Coin

Item Number: ET1210C-H

Product Labeling

Product labeling is subject to change.

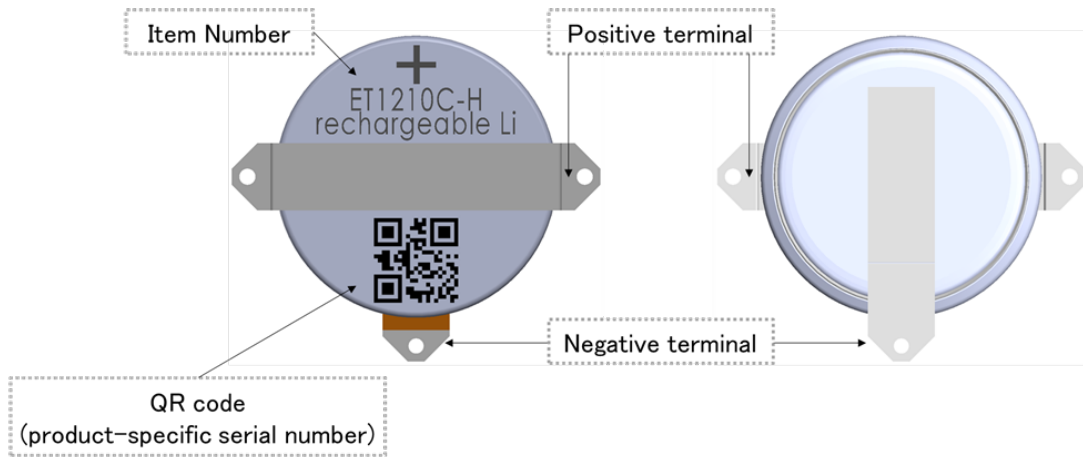

3. Standard

Cell complies with the following standards:

- UN38.3 (UN Recommendations on the TRANSPORT OF DANGEROUS GOODS – Manual of Tests and Criteria, Part III, Subsection 38.3, seventh revised edition (ST/SG/AC.10/11/Rev.7))
- IEC62133-2:2017 (Secondary cells and batteries containing alkaline or other non-acid electrolytes – Safety requirements for portable sealed secondary cells, and for batteries made from them, for use in portable applications –Part 2: Lithium systems) Certificate Number: DK-102918-UL



4. Safety Precautions

Before using Cell, be sure to read these 'Safety Precautions' and the 'User's Guide' carefully. After reading them, please keep them for later reference. If you do not understand any part of the User's Guide or the cautionary note, or if you have any questions, please contact our customer service (see below).

NGK Insulators, Ltd., Sales Department, Electronic Devices Division, Digital Society Business Group 2-56, Suda-cho, Mizuho-ku, Nagoya, Aichi, Japan 467-8530 Phone: 052-872-7935

【 Warning indication 】

These Safety Precautions describe important instructions that should be observed to ensure the safe use of Cell and to prevent damages to property or injuries to life or body of users and customers of your company as well as end users.

graphic symbol	meaning
 DANGER	mishandling may result in death or serious injury to the user, and the degree of urgency is high.
 WARNING	mishandling may result in death or serious injury to the user.
 CAUTION	mishandling may result in minor injury to the user, or the property damage.



Preparation before use

- Cell has a predetermined polarity (i.e. which side is positive or negative). If Cell does not connect well to the charger or equipment, do not try to connect Cell forcefully. If Cell is connected in reverse polarity, it will be recharged in reverse, causing an abnormal reaction internally, and may cause overheating, explosion, ignition or leakage of Cell, resulting in injuries.
- Do not connect Cell directly to an electric outlet or a cigarette lighter socket in a car without using the charger. Otherwise, an electric shock may be caused. Applying a high voltage may generate an excessive current, causing overheating, explosion, ignition or leakage of Cell, resulting in injuries.

Unintended use of Cell

- Cell is for industrial use only. Cell is not intended for use by general consumers as a stand-alone product (charge/discharge, integration into equipment, removal from equipment, etc.). If you intend to use Cell for any of the following purposes, please make sure to contact us beforehand.
 - Purposes for which extremely high reliability is required, such as use in systems, machines or equipment that may involve danger to human lives or property, including nuclear control systems, transport equipment (railways, vehicles, aircraft, ships, etc.), medical equipment or safety equipment
 - Other equivalent purposes that require a high level of safety

Usage of Cell

- Do not wet Cell with water, seawater, juice or other liquid, as this may cause overheating, explosion, ignition or leakage, resulting in injuries.
- Do not leave Cell near a heater, iron, hair dryer or other heat sources, as this may cause overheating, explosion, ignition or leakage, resulting in injuries.
- Use the exclusive charger to recharge Cell. Observe the recharging conditions specified by NGK. Recharging Cell under any other conditions (such as recharging at an inappropriate temperature, a high voltage or a large current flow other than specified by NGK, or using a modified recharger) may cause overheating, explosion, ignition or leakage, resulting in injuries.
- Do not throw Cell into fire, or heat it. Doing so may cause overheating, explosion, ignition or leakage of Cell, resulting in injuries.
- Do not let the positive and negative terminals of Cell come into contact with any metal. Do not carry or store Cell with metal objects such as a necklace or a hairpin. Doing so may short circuit Cell, which may result in excessive current flow, overheating, explosion, ignition or leakage of Cell, or overheating of the necklace, hairpin or other metal objects, resulting in injuries.
- Do not throw or apply strong shock to Cell by, for example, dropping a heavy object from a height onto Cell. Doing so may damage Cell components, resulting in recharging of Cell at an abnormal current and/or voltage. This may give rise to overheating, explosion, ignition or leakage of Cell, resulting in injuries.
- Do not drive a nail or other sharp object into, hammer or stamp on Cell. Doing so may cause deformation of Cell and/or damage to Cell components, resulting in overheating, explosion, ignition or leakage, and may lead to injuries.

- The cell is designed for mounting by reflow soldering, but there are restrictions on the mounting conditions (temperature, time, number of times). Please refer to the user guide attached to this specification for the reflow profile example condition by NGK. Reflow soldering under any other conditions may cause overheating, explosion, ignition or leakage, resulting in injuries.
- Do not use Cell together with a primary battery (such as a dry battery) or other secondary batteries of a different capacity, type or brand. Doing so may cause over-discharge during use or over-charge during charging. This may result in abnormal chemical reactions inside Cell, giving rise to overheating, explosion, ignition or leakage, and may lead to injuries.
- Do not disassemble or alter Cell, as this may cause a short circuit, overheating, explosion, ignition or leakage of Cell during disassembly or alteration, resulting in injuries.
- Do not recharge Cell near fire or in a sun-heated car. Such conditions of high temperature may render Cell un-chargeable or cause Cell to be recharged at an abnormal current or voltage, or damage the separator of Cell. This may cause an internal short circuit in Cell and result in overheating, explosion, ignition or leakage, leading to injuries.
- Use an appropriate circuit to prevent short circuiting. Any electricity-conducting metal coming in contact with the positive and negative electrodes of Cell may cause a short circuit and a large current flow. This may result in overheating, explosion, ignition or leakage of Cell, or overheating of such metal, causing injuries.
- Do not use non-insulated tools when servicing Cell or put Cell on a non-insulated workbench. Do not stack Cells on top of each other. Any electricity-conducting metal coming in contact with the positive and negative electrodes of Cell may cause a short circuit and a large current flow. This may result in overheating, explosion, ignition or leakage of Cell, or overheating of such metal, and may cause injuries.
- Do not subject the sealed portions and terminal part of Cell to any shocks. Doing so may cause the sealed portions to open and let the electrolyte leak. The electrolyte leaked from Cell may come into contact with the eyes or skin, causing eye disorders or skin irritation.
- Do not use or assemble old and new Cells together. Doing so may cause over-discharge during use or over-charge during charging. This may result in abnormal chemical reactions inside Cell, giving rise to overheating, explosion, ignition or leakage, causing injuries.

WARNING
Usage of Cell

- Do not put Cell in a microwave oven or a high-pressure container, or on an induction heating (IH) cooker. Sudden heat or damage to the seal of Cell may cause overheating, explosion, ignition or leakage, resulting in injuries.
- Please use genuine and authentic Cells manufactured and sold by NGK. Some imitation and altered products are not equipped with sufficient hazard prevention mechanisms. Do not use such products which may cause overheating, explosion, ignition or leakage. A Cell with no indication of the manufacturer's name or cautionary note is likely to be an imitation or altered product. Be careful when purchasing Cells.

Emergency measures

- If you notice any unusual odor, heat, discoloration, deformation or any other irregularities during use, recharging or storage of Cell, remove it from the equipment or the charger and do not use it. Continuing to use Cell in such a state may result in overheating, explosion, ignition or leakage, causing injuries.
- In the event of leakage or unusual odor from Cell, move it away from fire immediately. The leaked electrolyte may catch fire and cause explosion or ignition of Cell, causing injuries.
- If Cell leaks and the leaked fluid gets into contact with the eyes, flush the eyes with clean water (such as tap water) without rubbing and consult a doctor immediately. The leaked fluid, if left untreated, may cause eye disorders.
- If Cell leaks and its fluid comes in contact with skin or clothes, immediately wash the contact area with clean water (such as tap water). Otherwise, the leaked fluid may irritate skin.

Treatment during storage

- Keep Cell away from babies and young children. Swallowing Cell could materially affect the baby/child's body.
- Do not leave Cell near pets or other animals. Their biting or chewing on Cell may cause damage to Cell, resulting in overheating, explosion, ignition or leakage, leading to injuries.

Disposal and Recycling of used Cells

- Do not dispose of Cells as household waste. Cells disposed as household waste may be damaged in a garbage truck and cause a short circuit, resulting in fire or smoke.
- Follow the disposal and recycling rules of your state or municipality.-

Treatment during transport

- Proper packing is required to ensure that Cell does not move inside the container case during transport. Movement of Cell within the package may lead to damage or a short circuit between metal terminals, resulting in injuries.

CAUTION

Preparation before use

- Thoroughly read the User's Guide and learn the recharging method before recharging Cell and observe the specified recharging conditions. Recharging Cell under any other conditions may cause overheating, explosion, ignition or leakage.
- If you find damage, distortion, rust, unusual odor, overheating, leakage or other irregularities when using Cell for the first time after buying it, do not use it and contact NGK. Continued use may result in overheating, explosion, ignition or leakage of Cell.
- Cell has no overcharging/over discharging protection mechanism incorporated in it. When Cell is installed in equipment, incorporation of an appropriate protection circuit is recommended. Overcharging/over discharging during the charging/discharging process may lead to overheating, explosion, ignition or leakage of Cell.

Usage of Cell

- Do not use Cell in a location where static electricity is generated, as this may cause overheating, explosion, ignition or leakage of Cell.
- The temperature range for charging Cell is -20°C to 105°C . Charging outside this temperature range may lead to overheating, explosion, ignition or leakage of Cell.
- Do not let a child use Cell. Any use of Cell other than as instructed in the User's Guide may cause overheating, explosion, ignition or leakage of Cell.
- Do not cover Cell or place flammable materials on Cell while recharging or discharging. Doing so may result in overheating, explosion, ignition or leakage of Cell.

Disposal and Recycling of used Cells

- Be sure to insulate the metal terminals of used Cell with plastic tape or other insulating material. Failure to do so may cause a short circuit between the terminals of Cell, resulting in fire or smoke.

Please take the following actions to ensure the safety of the product.

- Please indicate on each product containing Cell that the said product is equipped with a lithium-ion battery cell.
- Please include the contents of the "Safety Precautions" of these Specifications in the Standard Specification for each product containing Cell.

5. Instructions for Use

5.1 Storage of Cell

(1) Conditions(Recommendation)

Please store Cell under the following conditions.

Temperature: between 5 and 30°C

Humidity Level: 70%RH or less, avoid water condensation

Avoid sudden changes in temperature or humidity, even under the above temperature and humidity conditions.

Do not store in direct sunlight.

Do not decompress Cell (e.g. vacuum pack) when storing.

Do not store Cell in acidic or alkaline environments or areas filled with corrosive gases.

Storage in an environment with less dust is recommended.

(2) Storage Method

Please store Cell in a packing reel and embossed carrier tape until use.

Do not apply strong force to the reel, embossed carrier tape or Cell.

5.2 Preparations Before Use/Precautions for Use

(1) Conditions

Charging/ Discharging temperature must be between -20 to 105°C。

※This temperature range does not guarantee that no defects will occur. Charging Cell in temperature environments of 105°C or more or below -20°C may accelerate the aging process of Cell or lead to breakdown, compared to charging Cell in a temperature environment between -20°C and 105°C.

(2) Picking Up Cell

Do not directly touch or apply strong force to the terminals.

Do not apply excessive force to Cell when picking it up.

Using suction tweezers to pick up Cell is recommended.

If suction tweezers are not available for use, use resinous tweezers with blunt ends (do not use tweezers with acute ends or metallic tweezers).

After picking up Cell, place Cell on a tray or table of insulating material.

(3) Cell Installation Specification

The cell is designed for mounting by reflow soldering, but there are restrictions on the mounting conditions (temperature, time, number of times).

Please refer to the user guide attached to this specification for the reflow profile example condition by NGK.



Do not charge before reflow mounting.

Reference reflow profile

Reference land pattern

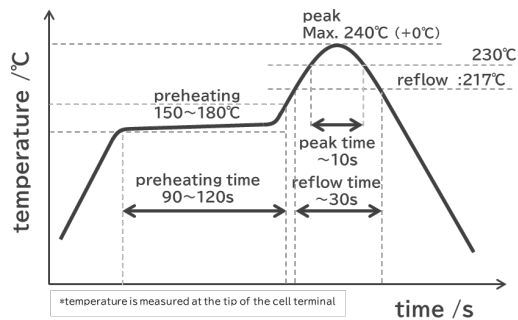

Reflow number limit: 1 time

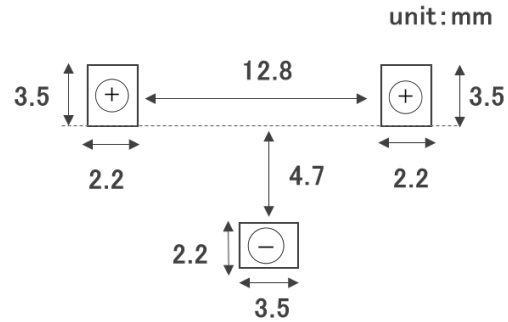

If you mount by soldering with a soldering iron, the temperature of the tip should be about 350°C within 3 seconds

(4) Charging

Please connect Cell correctly to a charger to avoid reverse charging.

Do not charge Cell using voltage that exceeds the operating voltage.

(5) Discharging

Do not discharge Cell below the discharge cut-off voltage

(6) Product Life

Cell has a limited product life. Its capacity gradually decreases with increased usage and the passage of time. Cell's product life may vary depending on how it is used.

Use of Cell at a continuous high temperature and in a highly humid location even within the operating temperature range may shorten the product life. Please contact us for details.

(7) Others

Cell is charged slightly before shipment, and it may be used to verify the operation of a device.

Please charge Cell with a dedicated charger before use if Cell cannot be used for such verification, it is not used for a long time, or it is to be used for a long time.

Do not use Cell if Cell or its terminals are dirty.

It is advisable to switch off the device to which Cell is connected, if such Cell is not in use.

When Cell is not used for a long time, store it in a less humid location. It must not be stored while it is connected to a device or kept in a humid location.

Please read this Guide or contact us for how to install Cell into and take out Cell from a device.

5.3 Transport

When transporting Cell, it is advisable to pack Cell in the same manner as it was packed upon shipment, in order to prevent damage. In addition, please avoid mechanical vibration or impact as much as possible (impact to or dropping Cell may damage it).

Packing labels and shipping documents may differ from one transport company to another. Please confirm with your transport company as to the details of the packing labels and shipping documents.

The transport of Cell will be subject to various treaties, laws, regulations, guidelines and/or other requirements, including, without limitation, the followings:

- UN Recommendations on the Transport of Dangerous Goods
- International Civil Aviation Organization (ICAO) Technical Instructions
- International Air Transport Association (IATA) Dangerous Goods Regulations
- International Maritime Organization (IMO) International Maritime Dangerous Goods Code

6. Hazardous Materials used in the Product

Please refer to the SDS (Safety Data Sheet).

7. Storage and Disposal (including recycling) of Used Cells

Do not place used Cells in the general trash. After using Cell, cover the terminals of Cell with proper insulating tape or put Cell separately into plastic bags and seal them individually (recommended).

After Cell is installed in the customer's product, the terminals of Cell must be treated accordingly to avoid being short-circuited, and should be disposed of in compliance with the latest laws, regulations, guidelines and other requirements of the relevant jurisdictions.

8. Technical Report

The following descriptions are for reference only and NGK makes no warranty hereunder.

Nominal Specifications

Item		Characteristics
Nominal Capacity (Standard Charge)		4.0mAh
Minimum Capacity (Standard Charge)		3.5mAh
Voltage	Operating Voltage	1.5~2.7V
	Nominal Voltage	2.3V
Current	1CmA	4.0mA
	Max. Charging Current	No limit
	Standard Discharging Current	0.8mA
	Peak Discharging Current *	20mA
Temperature	Operating Temperature Range	-20~105°C
Self-discharge amount (25°C)		About 5% /month (reference value)
Cell Weight		Less than 1g
Cell Dimension		As shown in the Exterior diagram

* Voltage drop is 0.5V with continuous discharge for 0.1 sec. (25°C)

Standard Charge

CV (Constant Voltage)

Voltage: 2.7V

Cut-off current: 0.02C

Exterior Diagram

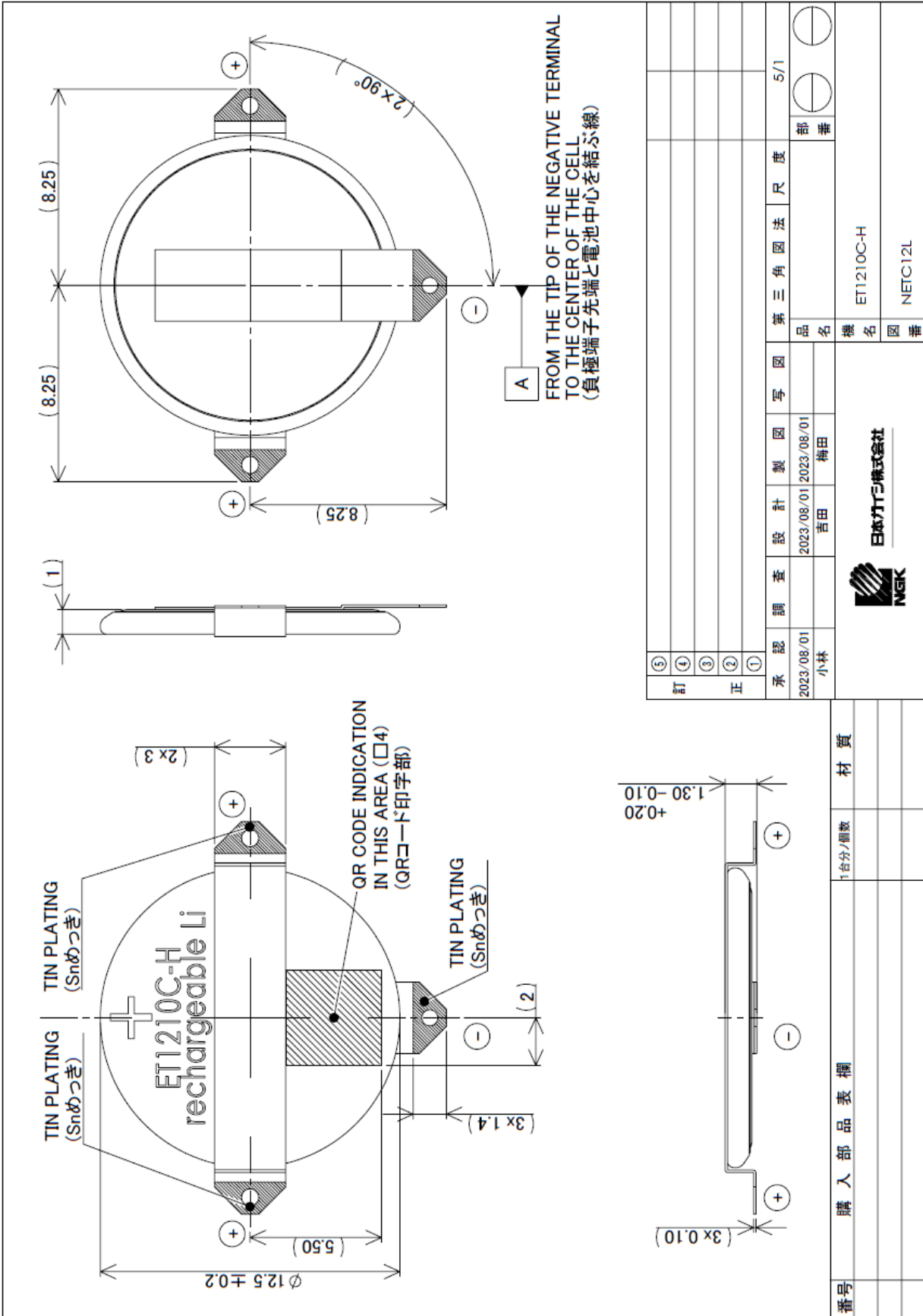

Structure and Cross-Sectional View Diagrams

Structure

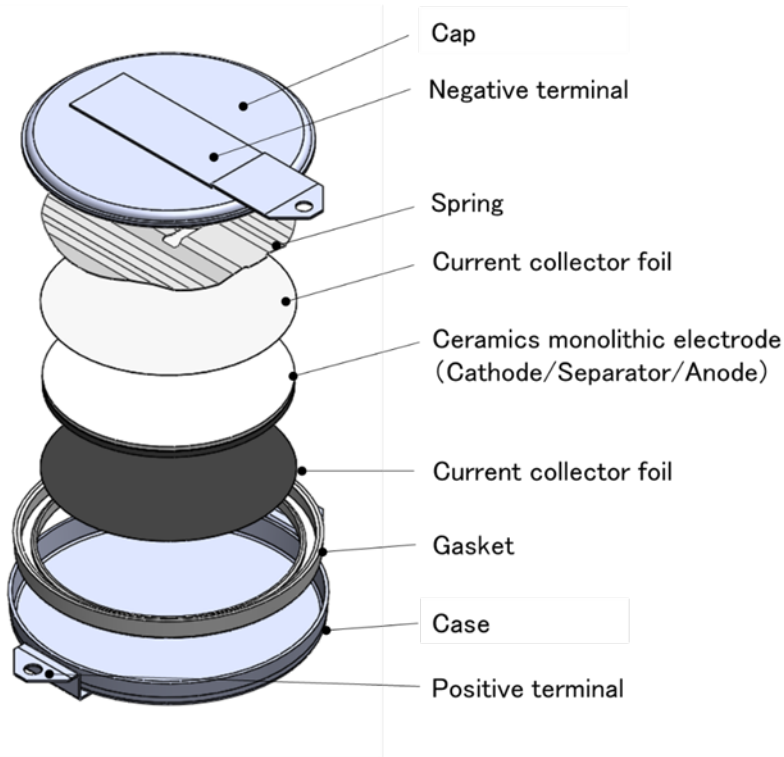

Cross-Sectional View

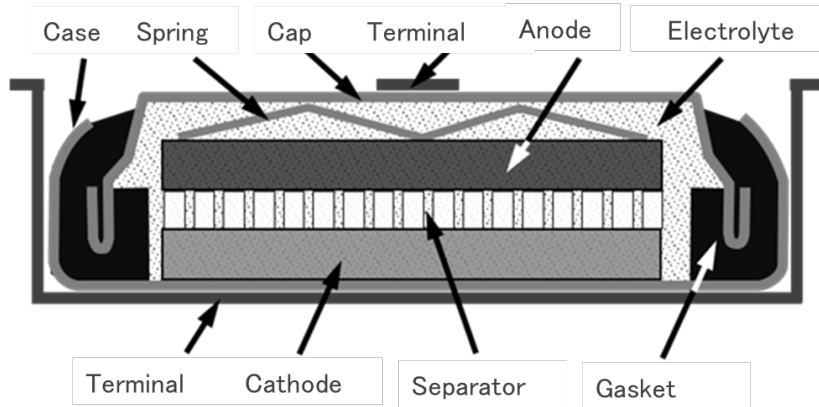

Reference Data

The reference data in the shipment state are shown below.

This item is for reference only and NGK does not make any warranty in this regard.

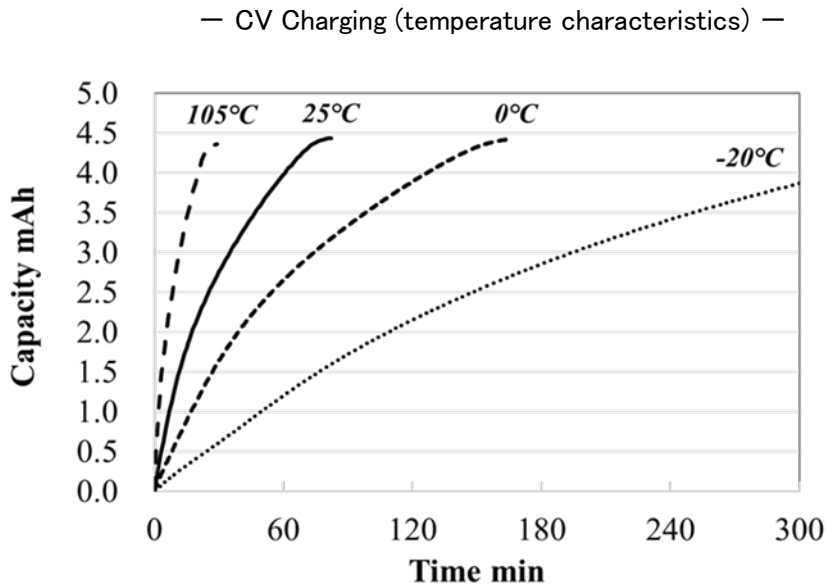
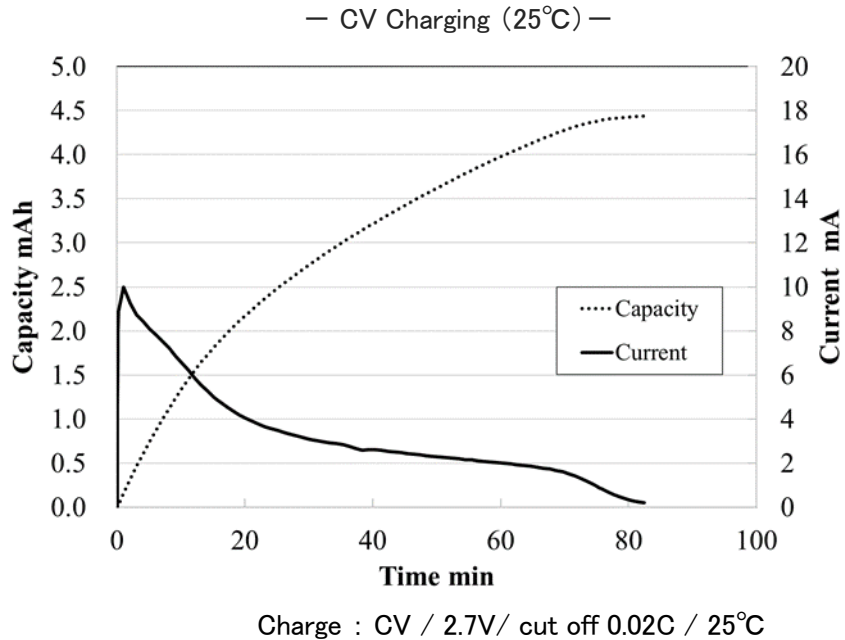

Charge : CV / 2.7V / cut off 0.02C / -20°C, 0°C, 25°C, 105°C

— Discharging (current dependency 25°C) —

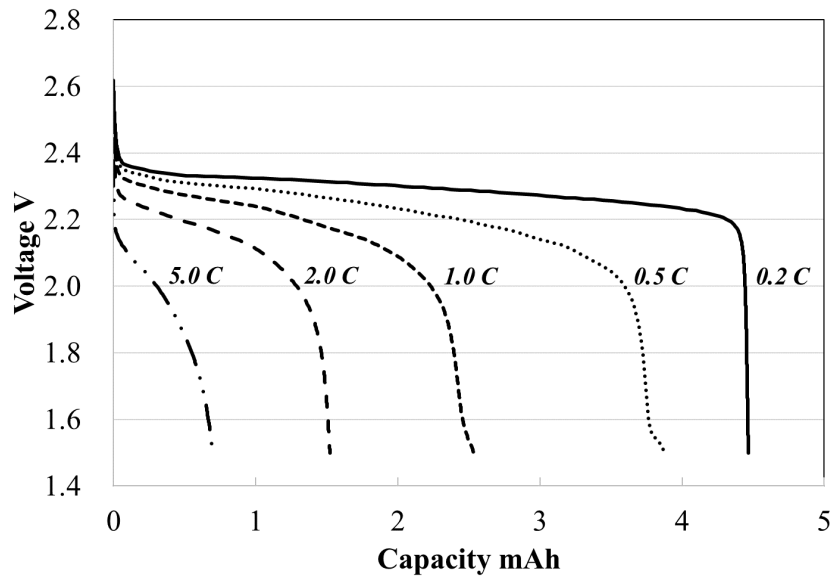

Discharge : CC / 0.2C、0.5C、1.0C、2.0C、5.0C / cut off 1.5V / 25°C

— Discharging (temperature characteristics) —

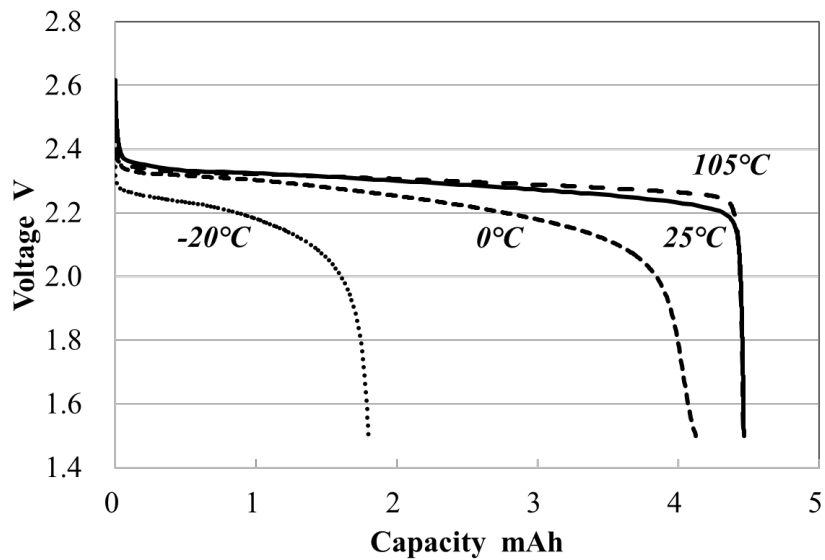

Discharge : CC / 0.2C / cut off 1.5V / -20°C、0°C、25°C、105°C

— Storage Characteristics (25°C) —

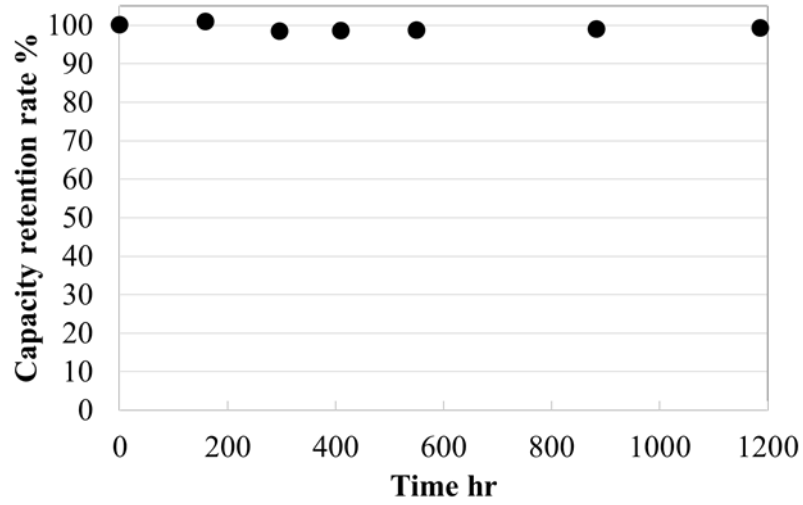

State of preservation: after standard charge/ 25°C

Capacity confirmation condition

Charge : CV / 2.7V / cut off 0.02C / 25°C

Discharge : CC / 0.1C / cut off 1.5V / 25°C

— Storage Characteristics (105°C) —

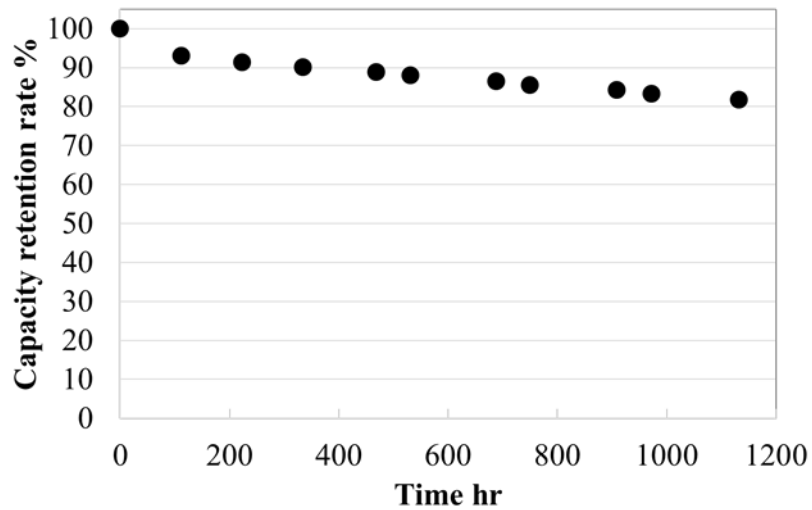

State of preservation: after standard charge/ 105°C

Capacity confirmation condition

Charge : CV / 2.7V / cut off 0.02C / 25°C

Discharge : CC / 0.1C / cut off 1.5V / 25°C

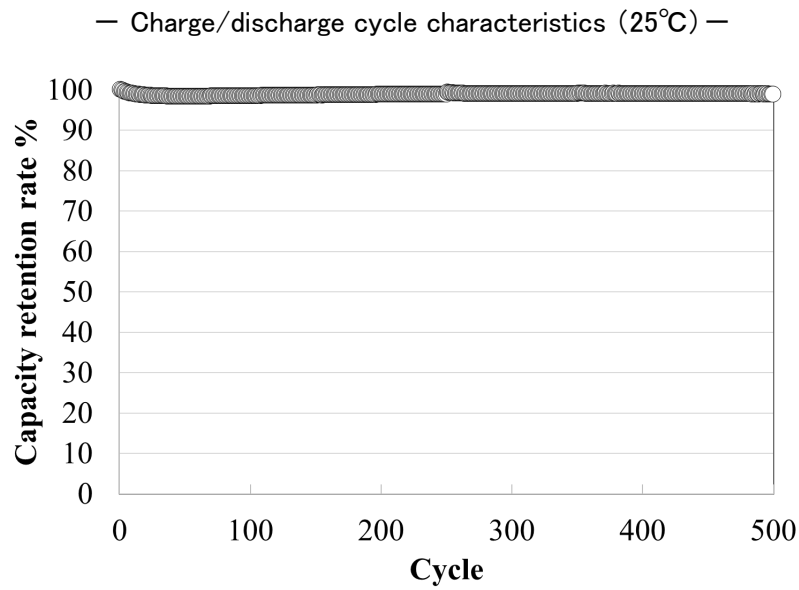

Charge : CV / 2.7V / cut off 0.02C / 25°C
 Discharge : CC / 0.1C / cut off 1.5V / 25°C

— Vibration test—

【Test method】

AEC-Q-200 Test No.14 (MIL-STD-202 Method204)。

Vibration test is performed according to the conditions shown in the table below.

Vibration frequency range	10~2000Hz	
total acceleration	5G	
1cyc	20min (10→2000→10Hz)	
number of cycles	X	12 cyc
	Y	
	Z	

【Test result】

There is no significant difference in cell capacity and resistance before and after the test.

We have confirmed that the Enercera Coin does not ignite or explode even if it is damaged beyond the requirements of safety standards, such as overcharging, nailing, crush, and high temperature heating.

The table below shows a list of safety test results for ET2016C–R, which has the highest energy in the Enercera coin series

Table. ET2016C–R List of safety test results

Test item	Contents of the test	Pass/Fail judgement	Result
Overcharge	Time: 3.5h Current: 100mA Temperature : 85°C	No ignition and/or explosion	Passed
Over discharge	Current: 50mA Temperature : 85°C		Passed
External short circuit	Short time: 1h Temperature: 57±4°C (UN38.3 T5)		Passed
Over voltage	Voltage: 24V Temperature: 85°C		Passed
Nail Penetration	Nail shape: diameter 2mm, angle 30° nail insertion speed: 2mm/s Temperature: 85°C		Passed
Crushing pressure	Load: 20kN Speed: 2mm/s Temperature: 85°C		Passed
Impact	Voltage: 2.7V The weight of 9.1kg is dropped from a height of 610±25mm Temperature: 25°C		Passed
Reduced pressure	Pressure: 11.6kPa or less Time: 6h Temperature: 20±5°C (UN38.3 T1)		Passed
Heating	Voltage: 2.7V Heat up to 550°C on a hot plate		Passed
Thermal shock	High temperature : 72±2°C、6h Low temperature : -40±2°C、6h Interval: 30min Cycle: 10cyc (UN38.3 T2)		Passed
Burning	Putting in a flame at 2.7V cell voltage	No explosion	Passed
Microwave heating	Heating in a microwave at 2.7V cell voltage		Passed

History of revisions

Ver.	Date	Description	Approved by	Prepared by
1	2022.12.1	Newly issued	Kobayashi	Yamazaki
2	2023.6.13	CAUTION: Correct description. 5.2(3) Cell Installation Specification: Correct description. 8. Technical Report Nominal Specifications: Correct description. 8. Technical Report Exterior: Correct exterior	Kobayashi	Yamazaki
3	2023.12.22	2. Product Description: Correct Structure. 8. Technical Report Exterior Diagram: correct exterior. 8. Technical Report Structure and Cross-Sectional View Diagrams : Correct Structure.	Kobayashi	Yamamoto